

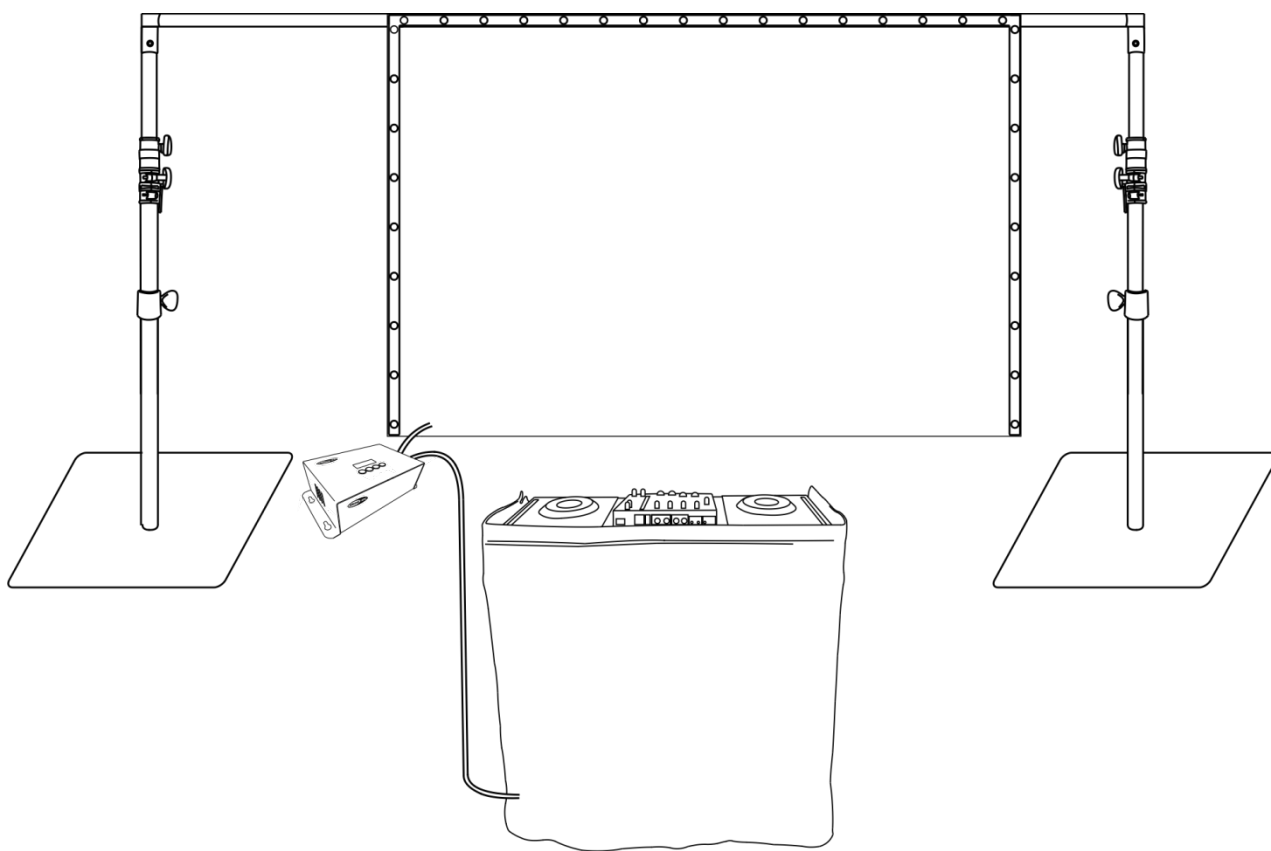

# MANUAL



ENGLISH

## Stardrape DJ Curtain Set V1

Ordercode: 40465

## Table of contents

---

<b>Warning</b> .....	2
Safety Instructions .....	2
Operating Determinations .....	4
Rigging .....	4
Connection with the mains.....	5
Return Procedure.....	6
Claims.....	6
<b>Description of the device</b> .....	7
Overview .....	8
Controller.....	9
<b>Installation</b> .....	9
<b>Set Up and Operation</b> .....	9
Control Modes.....	10
One Stardrape (Built-in programs and Full Mode) .....	10
One Stardrape (Sound-controlled) .....	10
Multiple Stardrapes (Master/Slave control) .....	10
Multiple Stardrapes (DMX Control).....	11
Fixture Linking .....	12
Data Cabling .....	12
Control Panel.....	13
Control Mode .....	13
DMX Addressing .....	13
Menu Overview .....	14
Main Menu Options.....	14
1. DMX-512 Mode and Master/Slave Mode .....	14
2. Built-in programs .....	14
3. Sound-controlled Mode .....	15
4. Full Mode.....	15
DMX Channels.....	15
8 channels.....	15
<b>Maintenance</b> .....	16
Replacing the Fuse.....	16
<b>Troubleshooting</b> .....	17
No Light.....	17
No Response to DMX.....	17
<b>Product Specifications</b> .....	19
<b>Dimensions</b> .....	20
<b>Notes</b> .....	21

## Warning



**For your own safety, please read this user manual carefully  
before your initial start-up!**



## Unpacking Instructions

Immediately upon receiving this product, carefully unpack the carton and check the contents to ensure that all parts are present, and have been received in good condition. Notify the dealer immediately and retain packing material for inspection if any parts appear damaged from shipping or the carton itself shows signs of mishandling. Save the carton and all packing materials. In the event that a fixture must be returned to the factory, it is important that the fixture be returned in the original factory box and packing.

### Your shipment includes:

- Showtec Stardrape DJ Curtain Set controller
- IEC power cable (1,5 m)
- Black curtain 2 m x 3 m (LxW)
- Black curtain 1,2 m x 2 m (LxW)
- User manual

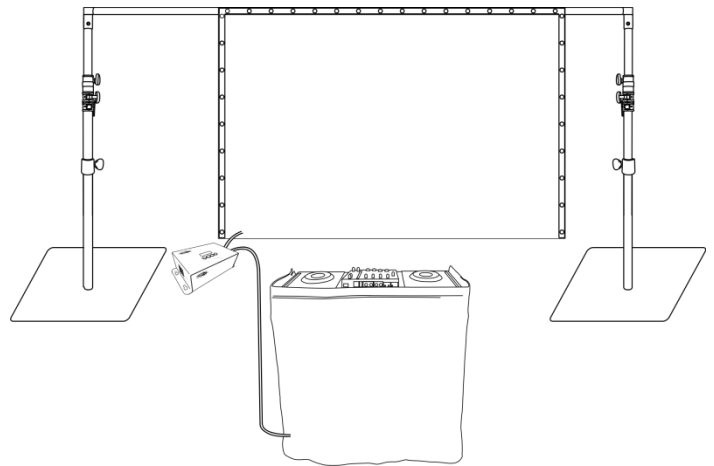

## LED Expected Lifespan

LEDs gradually decline in brightness over time. HEAT is the dominant factor that leads to the acceleration of this decline. Packaged in clusters, LEDs exhibit higher operating temperatures than in ideal or singular optimum conditions. For this reason, when all color LEDs are used at their fullest intensity, life of the LEDs is significantly reduced. If improving the lifespan is of higher priority, place care in providing for lower operational temperatures. This may include climatic-environmental and the reduction of overall projection intensity.



**CAUTION!**  
**Keep this device away from rain and moisture!**  
**Unplug mains lead before opening the housing!**



## Safety Instructions

Every person involved with the installation, operation and maintenance of this device has to:

- be qualified
- follow the instructions of this manual



**CAUTION! Be careful with your operations.**  
**With a dangerous voltage you can suffer  
a dangerous electric shock when touching the wires!**



Before the initial start-up, please make sure that there is no damage caused by transportation. Should there be any, consult your dealer and do not use the device.

To maintain perfect condition and to ensure a safe operation, it is absolutely necessary for the user to follow the safety instructions and warning notes contained in this manual.

Please consider that damages caused by manual modifications to the device are not subject to warranty.

This device contains no user-serviceable parts. Refer servicing to qualified technicians only.

### **IMPORTANT:**

The manufacturer will not accept liability for any resulting damages caused by the non-observance of this manual or any unauthorized modification to the device.

- Never let the power cord come into contact with other cables! Handle the power cord and all connections with the mains with particular caution!
- Never remove warning or informative labels from the unit.
- Never use anything to cover the ground contact.
- Never place any material over the LEDs.
- Never look directly into the light source.
- Never leave any cables lying around.
- Do not insert objects into air vents of the controller.
- Do not connect this device to a dimmerpack.
- Do not switch the device on and off in short intervals, as this will reduce the device's life.
- Do not touch the device's housing bare-handed during its operation (housing becomes very hot). Allow the fixture to cool for at least 5 minutes before handling.
- Do not shake the device. Avoid brute force when installing or operating the device.
- Only use the device indoors, avoid contact with water or other liquids.
- Only operate the fixture after having checked if the housing is firmly closed and all screws are tightly fastened.
- Only operate the device after having familiarized with its functions.
- Avoid flames and do not put close to flammable liquids or gases.
- Always keep the case closed while operating.
- Always allow a free air space of at least 50 cm around the unit for ventilation.
- Always disconnect power from the mains, when device is not used or before cleaning! Only handle the power cord holding it by the plug. Never pull out the plug by tugging the power cord.
- Make sure that the device is not exposed to extreme heat, moisture or dust.
- Make sure that the available voltage is not higher than stated on the rear panel.
- Make sure that the power cord is never crimped or damaged. Check the device and the power cord from time to time.
- If the LEDs are obviously damaged, they need to be replaced.
- If device was dropped or struck, disconnect mains power supply immediately. Have a qualified engineer inspect for safety before operating.
- If the device has been exposed to drastic temperature fluctuation (e.g. after transportation), do not switch it on immediately. The arising condensation water might damage your device. Leave the device switched off until it has reached room temperature.
- If your Showtec device fails to work properly, discontinue the use immediately. Pack the unit securely (preferably in the original packing material), and return it to your Showtec dealer for service.
- For adult use only. The fixture must be installed beyond the reach of children. Never leave the unit running unattended.
- Never attempt to bypass the thermostatic switch or fuses.
- For replacement use fuses of same type and rating only.
- The user is responsible for correct positioning and operating of the Stardrape. The manufacturer will not accept liability for damages caused by the misuse or incorrect installation of this device.
- This device falls under protection class I. Therefore it is essential to connect the yellow/green conductor to earth.
- Repairs, servicing and electric connection must be carried out by a qualified technician.
- **WARRANTY:** Till one year after date of purchase.



**CAUTION! Eyedamages!!!**  
**Avoid looking directly into the lightsource!!!**  
**(meant especially for epileptics)!!!**



## Operating Determinations

- This device is not designed for permanent operation. Consistent operation breaks will ensure that the device will serve you for a long time without defects.
- The minimum distance between light output and the illuminated surface must be bigger than 1 meter.
- The maximum ambient temperature  $t_a = 40^\circ\text{C}$  must never be exceeded.
- The relative humidity must not exceed 50 % with an ambient temperature of  $40^\circ\text{C}$ .
- If this device is operated in any other way than the one described in this manual, the product may suffer damages and the warranty becomes void.
- Any other operation may lead to dangers like short-circuit, burns, electric shock, crash, etc.

*You endanger your own safety and the safety of others!*

## Rigging

*Please follow the European and national guidelines concerning rigging, trussing and all other safety issues.*

*Do not attempt the installation yourself !*

*Always let the installation be carried out by an authorized dealer !*

## Procedure:

- If the Stardrape is lowered from the ceiling or high joists, professional trussing systems have to be used.
- Use the textile hook and loop fastener strips (Velcro) or tie-wraps/shock cords to install the Stardrape.
- The controller must never be fixed swinging freely in the room.
- The installation must always be secured with a safety attachment, e.g. an appropriate safety net or safety cable.
- When rigging, derigging or servicing the Stardrape, always make sure, that the area below the installation site is secured and that there are not any unauthorized people around.

## Stardrape Curtains

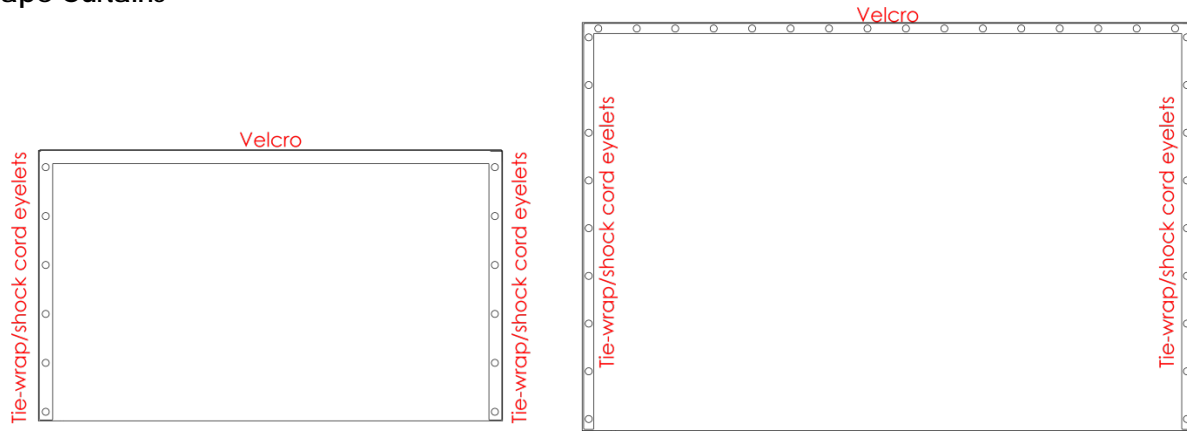

## Stardrape DJ Curtain Set – Wentex

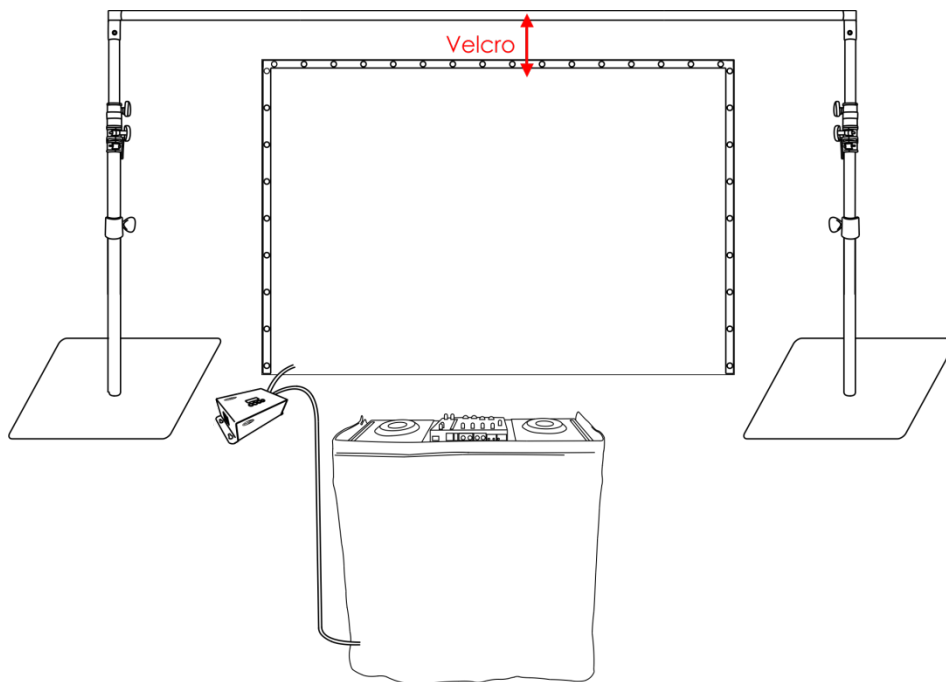

The Stardrape can be mounted to any kind of truss with hook and loop fasteners (Velcro) and/or tie-wraps/shock cords.

*Improper installation can cause serious injuries and/or damage of property!*

### Connection with the mains

Connect the device to the mains with the power-plug.

Always check if the right color cable is connected to the right place.

International	EU Cable	UK Cable	US Cable	Pin
L	BROWN	RED	YELLOW/COPPER	PHASE
N	BLUE	BLACK	SILVER	NEUTRAL
⊕	YELLOW/GREEN	GREEN	GREEN	PROTECTIVE GROUND

*Make sure that the device is always properly connected to the earth!*

*Improper installation can cause serious injuries and/or damage of property!*



### **Return Procedure**

Returned merchandise must be sent prepaid and in the original packing, call tags will not be issued. Package must be clearly labeled with a Return Authorization Number (RMA number). Products returned without an RMA number will be refused. Highlite will not accept the returned goods or any responsibility. Call Highlite 0031-455667723 or mail [aftersales@highlite.nl](mailto:aftersales@highlite.nl) and request an RMA prior to shipping the fixture. Be prepared to provide the model number, serial number and a brief description of the cause for the return. Be sure to properly pack fixture, any shipping damage resulting from inadequate packaging is the customer's responsibility. Highlite reserves the right to use its own discretion to repair or replace product(s). As a suggestion, proper UPS packing or double-boxing is always a safe method to use.

**Note: If you are given an RMA number, please include the following information on a piece of paper inside the box:**

- 01) Your name
- 02) Your address
- 03) Your phone number
- 04) A brief description of the symptoms

### **Claims**

The client has the obligation to check the delivered goods immediately upon delivery for any shortcomings and/or visible defects, or perform this check after our announcement that the goods are at their disposal. Damage incurred in shipping is the responsibility of the shipper; therefore the damage must be reported to the carrier upon receipt of merchandise.

It is the customer's responsibility to report and submit claims with the shipper in the event that a fixture is damaged due to shipping. Transportation damage has to be reported to us within one day after receipt of the delivery.

Any return shipment has to be made post-paid at all times. Return shipments must be accompanied with a letter defining the reason for return shipment. Non-prepaid return shipments will be refused, unless agreed otherwise in writing.

Complaints against us must be prepared in writing or sent by fax within 10 working days after receipt of the invoice. After this period complaints will not be handled anymore.

Complaints will only then be considered if the client has so far complied with all parts of the agreement, regardless of the agreement from which the obligation is resulting.

## Description of the device

### Features

The Stardrape DJ Curtain Set is a star curtain system with high output and great effects.

#### Curtain 1

Light source: 120 x 5050 RGBW LED  
Color mixing: RGBW  
Data connector: Fixed cable with a 5-pin female connector  
Curtain color: Black  
Material: Flame retardant molton  
Assembly: Velcro and tie-wraps/shock cords  
Dimensions: 2000 x 3000 mm (LxW)  
Weight: 3,7 kg

#### Curtain 2

Light source: 40 x 5050 RGBW LED  
Color mixing: RGBW  
Data connector: Fixed cable with a 5-pin female connector  
Curtain color: Black  
Material: Flame retardant molton  
Assembly: Velcro and tie-wraps/shock cords  
Dimensions: 1200 x 2000 mm (LxW)  
Weight: 2,8 kg

#### Controller

Input voltage: 100-240V AC 60/50Hz  
Power consumption: 30W  
Control: DMX, Built-in programs, Sound-controlled, Full  
Program: 17 patterns with speed control  
DMX channels: 8 channels  
DMX connector: 3-pin XLR IN/OUT  
Data connector: 5-pin male connector  
Color: Black  
Fuse: F2AL/250V  
Dimensions: 215 x 125 x 60 mm (LxWxH)  
Weight: 0,9 kg

#### Carrying bag

Dimensions: 580 x 330 x 220 mm (LxWxH)

#### Optional accessories (Wentex):

- 89300 – 2 x Baseplate
- 89310 – 2 x Baseplate pin
- 89330 – 2 x Telescopic upright – 2-way (180-300 cm)
- 89342 – 1 x Telescopic drape support

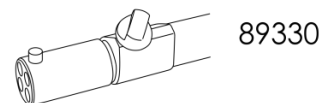
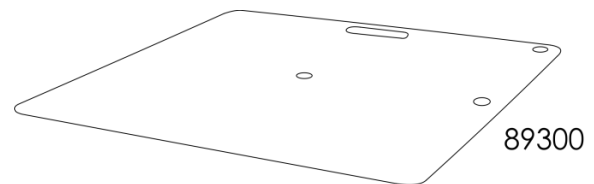

**Overview**

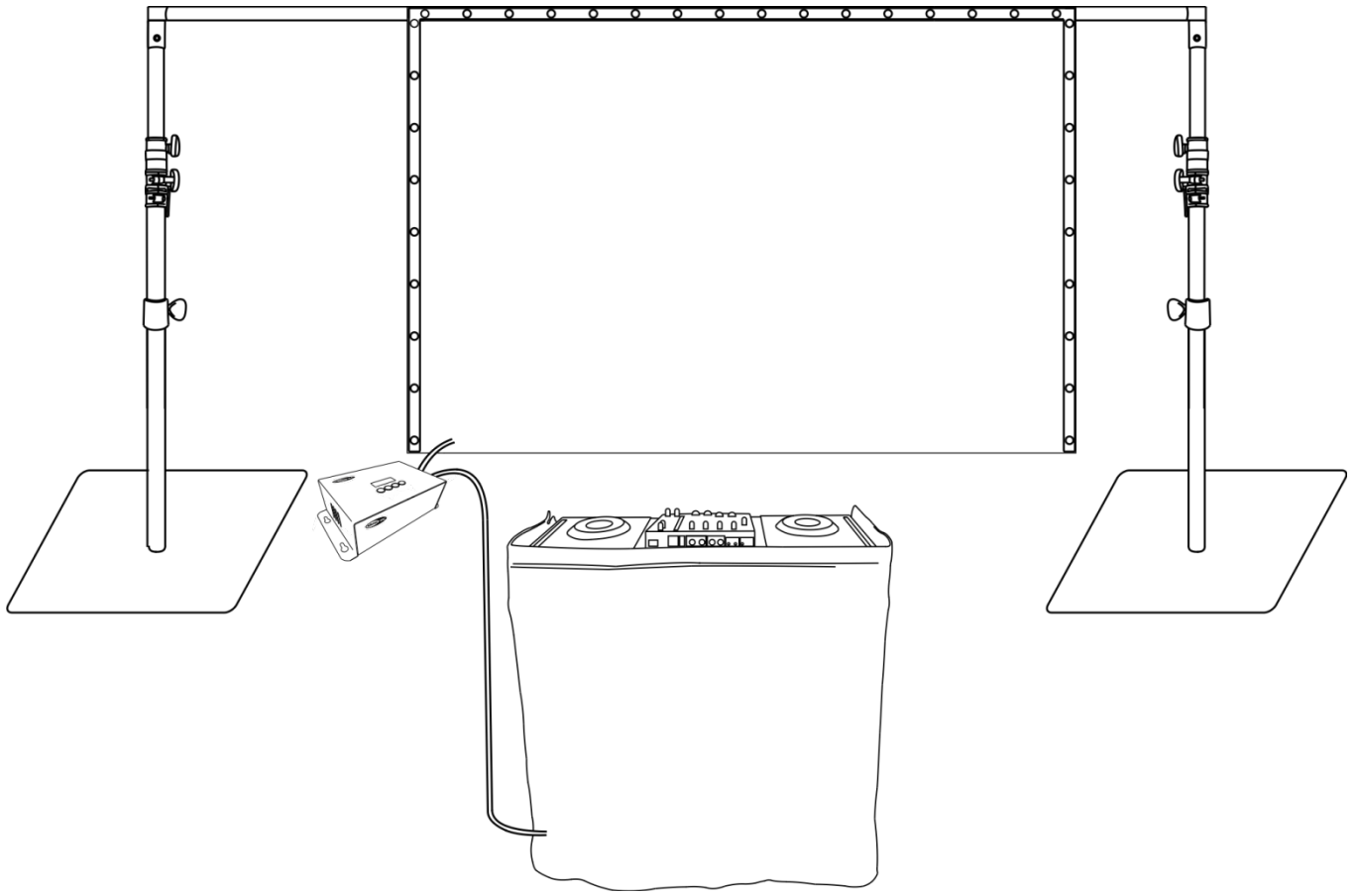

**Fig. 01**

## Controller

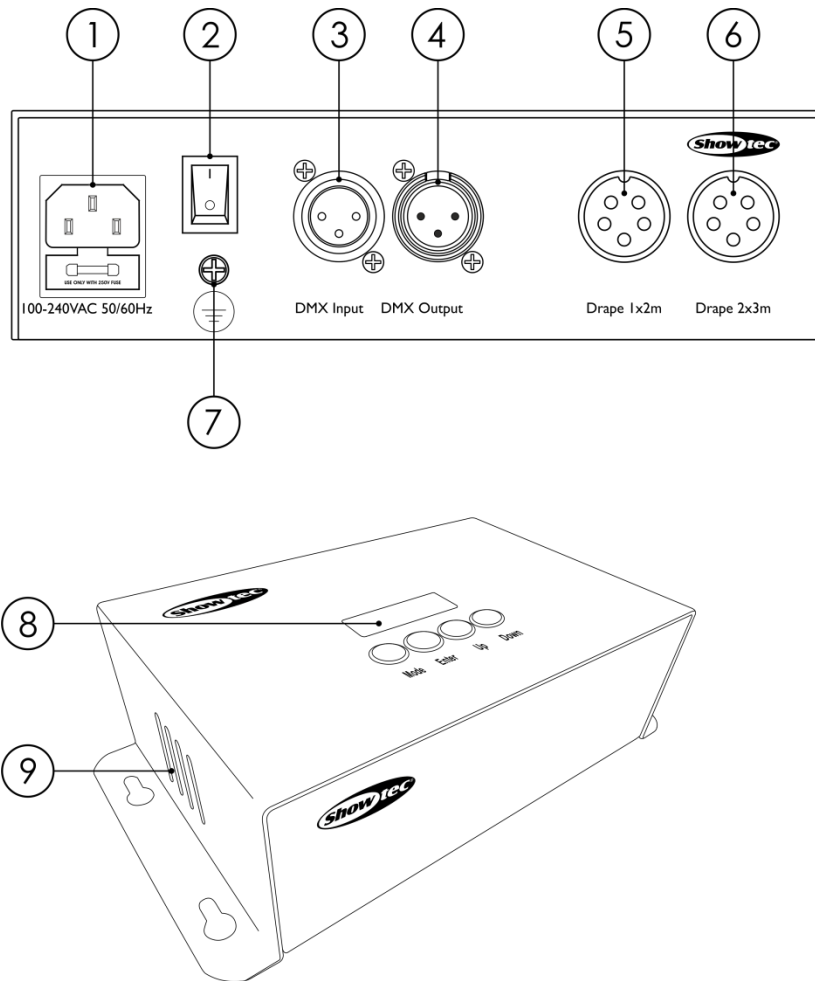

Fig. 02

- 01) IEC power connector 100-240V IN + Fuse F2AL/250V
- 02) Power switch ON/OFF
- 03) 3-pin DMX signal connector IN
- 04) 3-pin DMX signal connector OUT
- 05) 5-pin 1,2 m x 2 m curtain connector IN
- 06) 5-pin 2 m x 3 m curtain connector IN
- 07) Ground/earth connection
- 08) 4-digit LED display + menu buttons
- 09) Air intake grill

## Installation

Remove all packing materials from the Stardrape DJ Curtain Set. Check if all foam and plastic padding is removed. Connect all cables.

**Do not supply power before the whole system is set up and connected properly.**

**Always disconnect from electric mains power supply before cleaning or servicing.**

**Damages caused by non-observance are not subject to warranty.**

## Set Up and Operation

Follow the directions below, as they pertain to your preferred operation mode.

Before plugging the unit in, always make sure that the power supply matches the product specification voltage. Do not attempt to operate a 120V specification product on 230V power, or vice versa.

Connect the device to the main power supply.

## Control Modes

There are 5 modes:

- Built-in programs
- Full Mode
- Sound-controlled
- Master/Slave
- DMX-512 (8CH)

### One Stardrape (Built-in programs and Full Mode)

- 01) Fasten the effect light to a firm trussing. Leave at least 0,5 meter on all sides for air circulation.
- 02) Plug the end of the electric mains power cord into a proper electric power supply socket.
- 03) When the Stardrape is not connected with a DMX cable, it functions as a stand-alone device. Please see pages 14 and 15 for more information about the Built-in programs and Full Mode.

### One Stardrape (Sound-controlled)

- 01) Fasten the effect light to a firm trussing. Leave at least 0,5 meter on all sides for air circulation.
- 02) Plug the end of the electric mains power cord into a proper electric power supply socket.
- 03) Turn on the music. If the device is set to sound-control, then the Stardrape will react to the beat of the music. Please see page 15 for more information about the sound-control options.

### Multiple Stardrapes (Master/Slave control)

- 01) Fasten the effect light onto firm trussing. Leave at least 0,5 meter on all sides for air circulation.
- 02) Use a 3-pin XLR cable to connect the Stardrape.

The pins:



- 01) Earth
- 02) Signal -
- 03) Signal +

- 03) Link the units as shown in fig. 03. Connect the first unit's DMX "out" socket with the second unit's "in" socket, using a DMX-signal cable. Repeat this process to link the second, third, and fourth units. You can use the same functions on the master device as described on pages 14-15 (Built-in programs, Full Mode or Sound-controlled Mode). This means that you can set your desired operation mode on the master device and all slave devices will react the same as the master device. However, the DMX address of the slave devices must be the same as the one of the master device.

### Multiple Stardrapes (Master/Slave control)

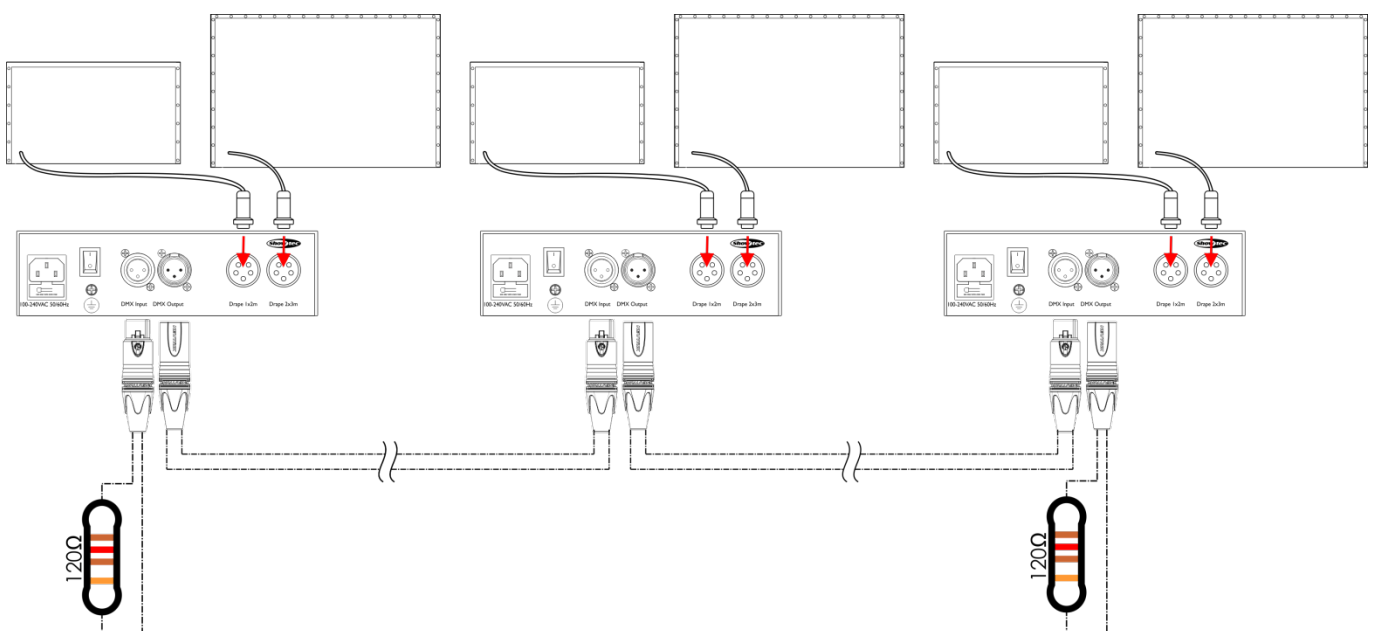
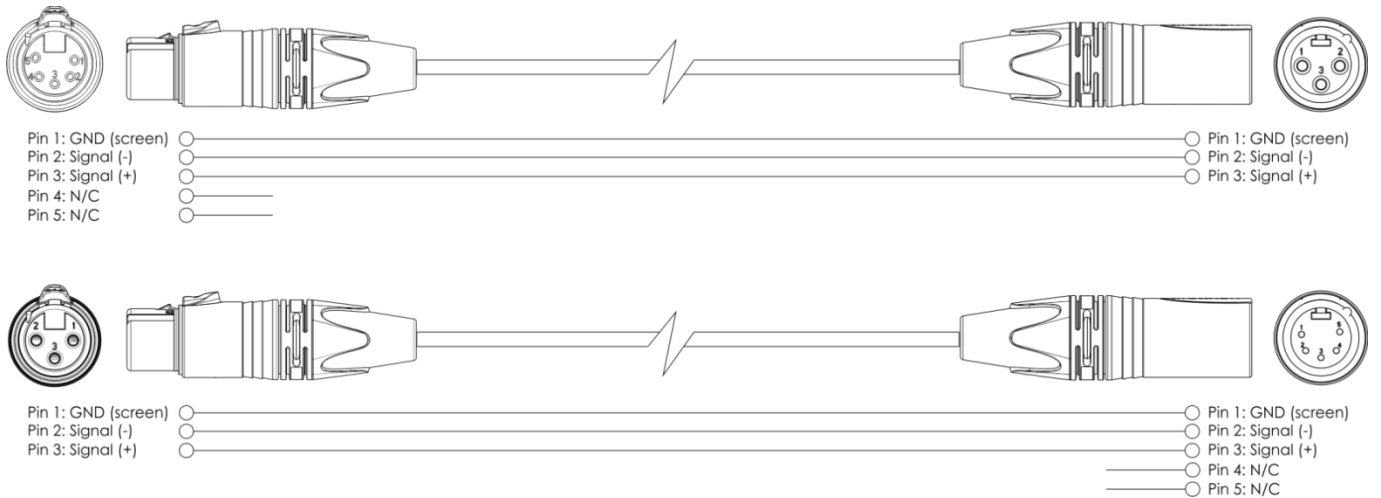

Fig. 03

## Multiple Stardrapes (DMX Control)

- 01) Fasten the effect light to a firm trussing. Leave at least 0,5 meter on all sides for air circulation.
- 02) Always use a safety cable (ordercode 70140 / 70141).
- 03) Use a 3-pin XLR cable to connect the Stardrapes and other devices.



- 04) Link the units as shown in fig. 04. Connect the first unit's DMX "out" socket with the second unit's "in" socket, using a DMX-signal cable. Repeat this process to link the second, third, and fourth units.
- 05) Supply electric power: Plug electric mains power cords into each unit's IEC socket, then plug the other end of the mains power cord into proper electric power supply sockets, starting with the first unit. Do not supply power before the whole system is set up and connected properly.

## Multiple Stardrapes DMX Set Up

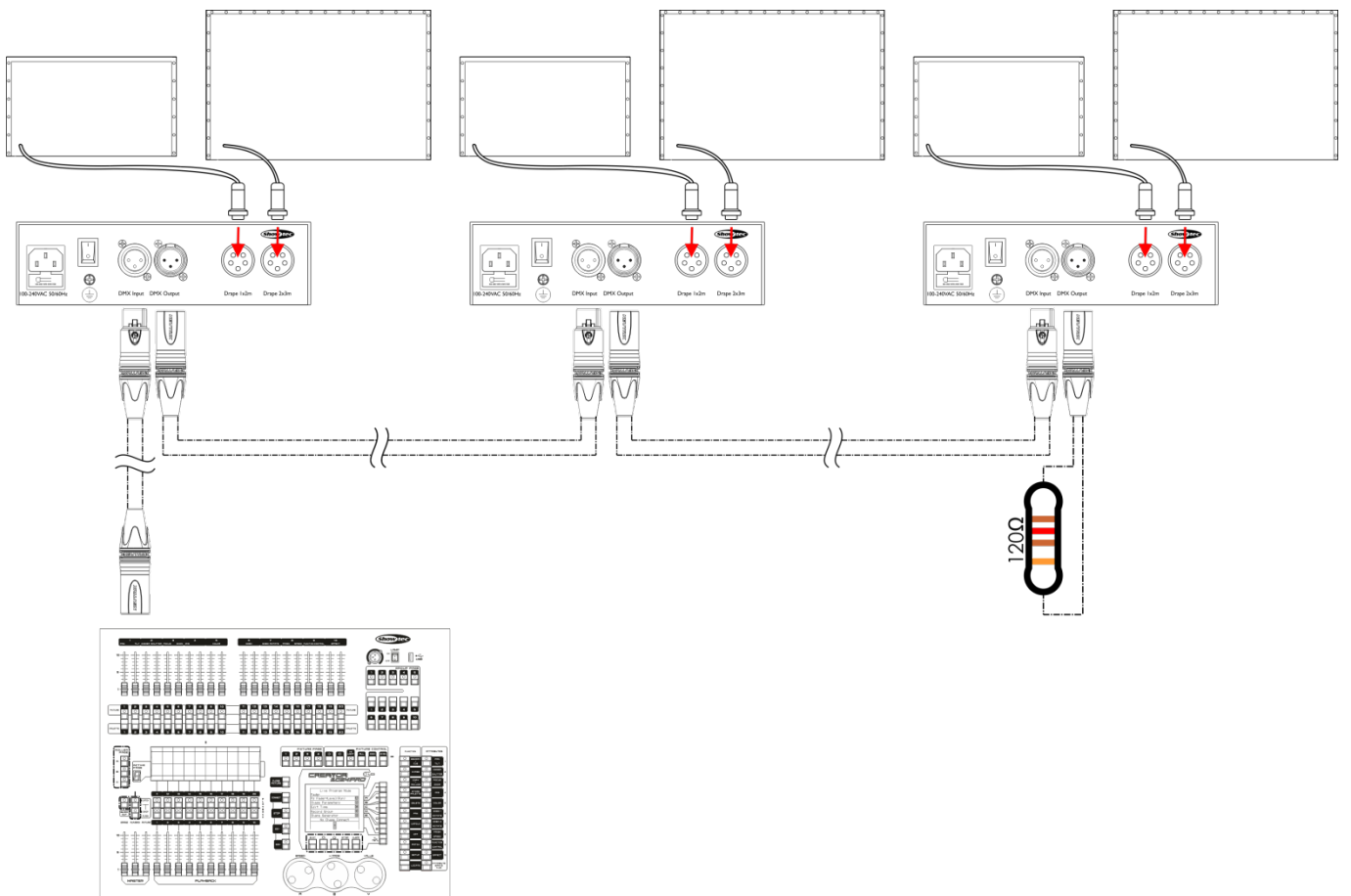

Note : Link all cables before connecting electric power

Fig. 04

## Fixture Linking

You will need a serial data link to run light shows of one or more fixtures using a DMX-512 controller or to run synchronized shows of two or more fixtures set to a master/slave operating mode. The combined number of channels required by all the fixtures on a serial data link determines the number of fixtures the data link can support.

**Important:** Fixtures on a serial data link must be daisy-chained in a single line. To comply with the EIA-485 standard, no more than 30 devices should be connected on one data link. Connecting more than 30 fixtures on one serial data link without the use of a DMX optically isolated splitter may result in deterioration of the digital DMX signal.



Maximum recommended DMX data link distance: 100 meters  
Maximum recommended number of fixtures on a DMX data link: 30 fixtures

## Data Cabling

To link fixtures together, you must obtain data cables. You can purchase DAP Audio certified DMX cables directly from a dealer/distributor or construct your own cable. If you choose to create your own cable, please use data-grade cables that can carry a high quality signal and are less prone to electromagnetic interference.

### DAP Audio DMX Data Cables

- DAP Audio Basic microphone cable for allround use. bal. XLR/M 3-pin > XLR/F 3-pin. **Ordercode** FL01150 (1,5 m), FL013 (3 m), FL016 (6 m), FL0110 (10 m), FL0115 (15 m), FL0120 (20 m).
- DAP Audio X-type data cable XLR/M 3-pin > XLR/F 3-pin. **Ordercode** FLX0175 (0,75 m), FLX01150 (1,5 m), FLX013 (3 m), FLX016 (6 m), FLX0110 (10 m).
- DAP Audio cable for the demanding user with exceptional audio-qualities and connector made by Neutrik®. **Ordercode** FL71150 (1,5 m), FL713 (3 m), FL716 (6 m), FL7110 (10 m).
- DAP Audio cable for the demanding user with exceptional audio-qualities and connector made by Neutrik®. **Ordercode** FL7275 (0,75 m), FL72150 (1,5 m), FL723 (3 m), FL726 (6 m), FL7210 (10 m).
- DAP Audio 110 Ohm cable with digital signal transmission. **Ordercode** FL0975 (0,75 m), FL09150 (1,5 m), FL093 (3 m), FL096 (6 m), FL0910 (10 m), FL0915 (15 m), FL0920 (20 m).

The Stardrape can be operated with a controller in **control mode** or without the controller in **stand-alone mode**.

### Control Panel

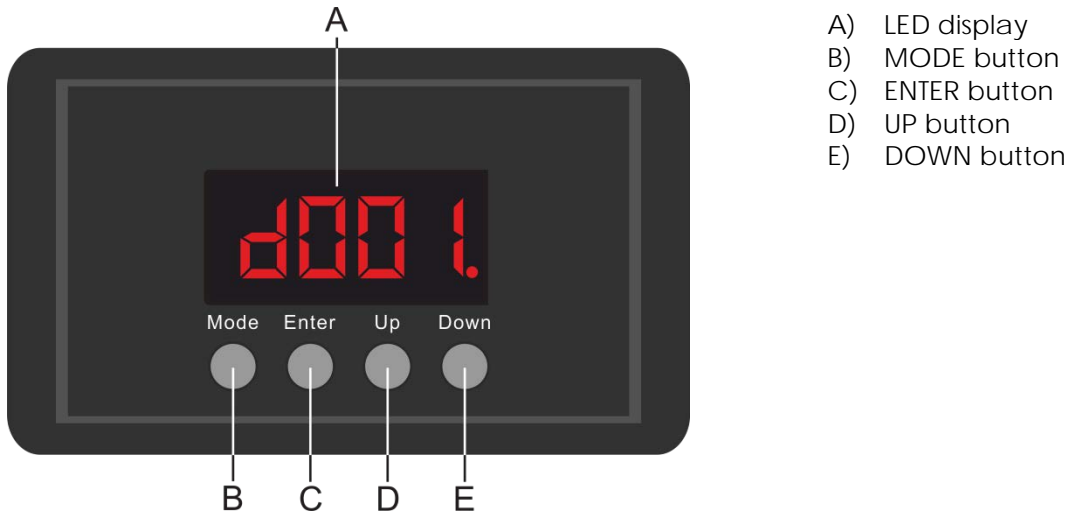

Fig. 05

### Control Mode

The fixtures are individually addressed on a data-link and connected to the controller. The fixtures respond to the DMX signal from the controller. (When you select the DMX address and save it, the controller will display the saved DMX address, next time.)

### DMX Addressing

The control panel on the front side of the base allows you to assign DMX fixture addresses, which is the first channel with which the Stardrape will respond to the controller.

Please note, when you use the controller, the unit has **8** channels.

When using multiple Stardrapes, make sure you set the DMX addresses right.

Therefore, the DMX address of the first Stardrape should be **1(001)**; the DMX address of the second Stardrape should be **1+8=9 (009)**; the DMX address of the third Stardrape should be **9+8=17 (017)**, etc. Please, be sure that you do not have any overlapping channels in order to control each Stardrape correctly. If two or more Stardrapes are addressed similarly, they will work similarly.

### Controlling:

After having addressed all Stardrape fixtures, you may now start operating these via your lighting controller.

**Note:** After switching on, the Stardrape will automatically detect whether DMX 512 data is received or not.

If there is no data received at the DMX-input, the "LED" on the control panel will not flash.

If not, the problem may be:

- The XLR cable from the controller is not connected with the input of the Stardrape DJ Curtain Set.
- The controller is switched off or defective, the cable or connector is defective, or the signal wires are swapped in the input connector.

**Note:** It is necessary to insert an XLR termination plug (with 120 Ohm) in the last fixture in order to ensure proper transmission on the DMX data link.

## Menu Overview



## Main Menu Options

<b>d001.</b>	DMX-512 Mode and Master/Slave Mode
<b>Pro.</b>	Built-in programs
<b>Sond.</b>	Sound-controlled Mode
<b>FULL.</b>	Full Mode

### 1. DMX-512 Mode and Master/Slave Mode

With this menu, you can set the DMX address.

- 01) Press the **MODE** button until the display shows **d001.**
- 02) Press the **ENTER** button to open the menu.
- 03) Press the **UP/DOWN** buttons to choose the desired DMX address. The adjustment range is between **d001** <sup>Up/Down</sup> **d512**.
- 04) If all the connected Stardrapes use the same DMX address, they will react the same as the first device (Master/Slave Mode).

### 2. Built-in programs

With this menu, you can set the built-in programs.

- 01) Press the **MODE** button until the display shows **Pro.**
- 02) Press the **ENTER** button to open the menu.
- 03) Press the **UP/DOWN** buttons to toggle between the following 2 options:
 

<b>PU01.</b>	Built-in programs
<b>SP01.</b>	Program speed
- 04) When the display shows **PU01.**, press the **ENTER** button to open the menu.
- 05) Press the **UP/DOWN** buttons to choose the desired built-in program. The adjustment range is between **PU01** <sup>Up/Down</sup> **PU17**.
- 06) The device will now run the desired built-in program.
- 07) When the display shows **SP01.**, press the **ENTER** button to open the menu.

08) Press the **UP/DOWN** buttons to increase/decrease the program speed. The adjustment range is between **SP01** <sup>Up/Down</sup> **SP20**, from slow to fast.

### 3. Sound-controlled Mode

With this menu, you can set Sound-controlled Mode.

- 01) Press the **MODE** button until the display shows **Sound.**
- 02) Sound-controlled Mode is now active and the device will react to the beat of the background music.

### 4. Full Mode

With this menu, you can set Full Mode.

- 01) Press the **MODE** button until the display shows **FULL.**
- 02) Full Mode is now active and the device will operate at FULL ON setting.

## DMX Channels

### 8 channels

#### Channel 1 – Built-in programs/Dimmer intensity

0	Built-in programs Mode
1-255	Gradual adjustment dimmer, from dark to brightest 0-100%

#### Channel 2 – Strobe

0-255	Strobe flash frequency, from slow to fast
-------	---

#### Channel 3 – Built-in programs Dimmer must be closed

0-9	Not functional
10-23	Program 1
24-37	Program 2
38-51	Program 3
52-65	Program 4
66-79	Program 5
80-93	Program 6
94-107	Program 7
108-121	Program 8
122-135	Program 9
136-149	Program 10
150-163	Program 11
164-177	Program 12
178-191	Program 13
192-205	Program 14
206-219	Program 15
220-233	Program 16
234-255	Program 17

#### Channel 4 – Program speed Dimmer must be closed

0-255	Program speed, from slow to fast
-------	----------------------------------

#### Channel 5 – Red Dimmer must be set between 1-255

0-255	Gradual adjustment Red, from 0-100%
-------	-------------------------------------

**Channel 6 – Green** ⚠ **Dimmer must be set between 1-255** ⚠  
0-255      Gradual adjustment Green, from 0-100%

**Channel 7 – Blue** ⚠ **Dimmer must be set between 1-255** ⚠  
0-255      Gradual adjustment Blue, from 0-100%

**Channel 8 – White** ⚠ **Dimmer must be set between 1-255** ⚠  
0-255      Gradual adjustment White, from 0-100%

## Maintenance

The operator has to make sure that safety-related and machine-technical installations are to be inspected by an expert after every year in the course of an acceptance test.

The operator has to make sure that safety-related and machine-technical installations are to be inspected by a skilled person once a year.

The following points have to be considered during the inspection:

- 01) All screws used for installing the device or parts of the device have to be tightly connected and must not be corroded.
- 02) There may not be any deformations on housings, fixations and installation spots.
- 03) Mechanically moving parts like axles, eyes and others may not show any traces of wearing.
- 04) The electric power supply cables must not show any damages or material fatigue.

The Stardrape DJ Curtain Set requires almost no maintenance. However, you should keep the unit clean. Otherwise, the fixture's light output will be significantly reduced. Disconnect the mains power supply, and then wipe the cover with a damp cloth. Do not immerse in liquid. Wipe LEDs clean with glass cleaner and a soft cloth. Do not use alcohol or solvents.

The front lens will require weekly cleaning, as smoke-fluid tends to build up residues, reducing the light output very quickly.

Please clean internal components once a year with a light brush and vacuum cleaner.

Keep connections clean. Disconnect electric power, and then wipe the DMX and audio connections with a damp cloth. Make sure connections are thoroughly dry before linking equipment or supplying electric power.

## Replacing the Fuse

Power surges, short-circuit or inappropriate electrical power supply may cause a fuse to burn out.

If the fuse burns out, the product will not function whatsoever. If this happens, follow the directions below:

- 01) Unplug the unit from electric power source.
- 02) Insert a flat-headed screwdriver into a slot in the fuse cover. Gently pry up the fuse cover. The fuse will come out.
- 03) Remove the used fuse. If brown or unclear, it is burned out.
- 04) Insert the replacement fuse into the holder. Reinsert the fuse cover. Be sure to use a fuse of the same type and specification. See the product specification label for details.

### Troubleshooting

---

This troubleshooting guide is meant to help solve simple problems.

If a problem occurs, carry out the steps below in sequence until a solution is found. Once the unit operates properly, do not carry out following steps.

#### No Light

If the light effect does not operate properly, refer servicing to a technician.

Suspect three potential problem areas as: the power supply, the LEDs, the fuse.

- 01) Power supply. Check if the controller is plugged into an appropriate power supply.
- 02) The LEDs. Return the Stardrape to your Showtec dealer.
- 03) The fuse. Replace the fuse. See page 16 for replacing the fuse.
- 04) If all of the above appears to be O.K., plug the unit in again.
- 05) If you are unable to determine the cause of the problem, do not open the Stardrape zip fastener, as this may damage the unit and the warranty will become void.
- 06) Return the device to your Showtec dealer.

#### No Response to DMX

Suspect the DMX cable or connectors, a controller malfunction, a light effect DMX card malfunction.

- 01) Check the DMX setting. Make sure that DMX addresses are correct.
- 02) Check the DMX cable: Unplug the unit; change the DMX cable; then reconnect to electrical power. Try your DMX control again.
- 03) Determine whether the controller or light effect is at fault. Does the controller operate properly with other DMX products? If not, take the controller in for repair. If so, take the DMX cable and the light effect to a qualified technician.

Problem	Probable cause(s)	Solution
One or more fixtures do not function at all	No power to the fixture	<ul style="list-style-type: none"> <li>Check if power is switched on and cables are plugged in</li> </ul>
	Primary fuse blown	<ul style="list-style-type: none"> <li>Replace fuse</li> </ul>
Fixtures reset correctly, but all respond erratically or not at all to the controller	The controller is not connected.	<ul style="list-style-type: none"> <li>Connect controller.</li> </ul>
	3-pin XLR Out of the controller does not match XLR Out of the first fixture on the link (i.e. signal is reversed)	<ul style="list-style-type: none"> <li>Install a phase reversing cable between the controller and the first fixture on the link</li> </ul>
Fixtures reset correctly, but some respond erratically or not at all to the controller	Poor data quality	<ul style="list-style-type: none"> <li>Check data quality. If much lower than 100 percent, the problem may be a bad data link connection, poor quality or broken cables, missing termination plug, or a defective fixture disturbing the link</li> </ul>
	Bad data link connection	<ul style="list-style-type: none"> <li>Inspect connections and cables. Correct poor connections. Repair or replace damaged cables</li> </ul>
	Data link not terminated with 120 Ohm termination plug	<ul style="list-style-type: none"> <li>Insert termination plug in output jack of the last fixture on the link</li> </ul>
	Incorrect addressing of the fixtures	<ul style="list-style-type: none"> <li>Check address setting</li> </ul>
	One of the fixtures is defective and disturbs data transmission on the link	<ul style="list-style-type: none"> <li>Bypass one fixture at a time until normal operation is restored: unplug both connectors and connect them directly together.</li> <li>Have the defective fixture serviced by a qualified technician</li> </ul>
	3-pin XLR Out on the fixtures does not match (pins 2 and 3 reversed)	<ul style="list-style-type: none"> <li>Install a phase-reversing cable between the fixtures or swap pin 2 and 3 in the fixture that behaves erratically</li> </ul>
No light or lamp cuts out intermittently	Fixture is too hot	<ul style="list-style-type: none"> <li>Allow the fixture to cool down</li> <li>Clean the fan</li> <li>Make sure air vents in control panel and the front lens are not blocked</li> <li>Turn up the air conditioning</li> </ul>
	LEDs damaged	<ul style="list-style-type: none"> <li>Disconnect the fixture and return it to your dealer</li> </ul>
	The power supply settings do not match local AC voltage and frequency	<ul style="list-style-type: none"> <li>Disconnect fixture. Check settings and correct if necessary</li> </ul>

## Product Specifications

Model:	Showtec Stardrape DJ Curtain Set
Input Voltage:	100-240 VAC, 60/50Hz
Power consumption:	30W
DMX linking:	30pcs
Fuse:	F2AL/250V
Dimensions curtain 1:	2000 x 3000 mm (LxW)
Dimensions curtain 2:	1200 x 2000 mm (LxW)
Weight curtain 1:	3,7 kg
Weight curtain 2:	2,8 kg
Dimensions controller:	215 x 125 x 60 mm (LxWxH)
Weight controller:	0,9 kg
<b>Operating and Programming:</b>	
Signal pin OUT:	Pin 1 (earth), pin 2 (-), pin 3 (+)
DMX Mode:	8 channels
Signal input:	3-pin DMX IN
Signal output:	3-pin DMX OUT
<b>Electro-mechanical effects:</b>	
LED quantity, curtain 1:	120 x 5050 RGBW LED
LED quantity, curtain 2:	40 x 5050 RGBW LED
Dimmer:	0-100%
Strobe:	0-20Hz
Housing:	Metal & Flame retardant plastic
DMX-control:	via standard DMX-controller
Onboard:	4-digit LED display for easy setup
Control:	DMX, Built-in programs, Sound-controlled, Full
Connections:	Dedicated Schuko to IEC & Data connector
Cooling:	Internal fan
Max. ambient temperature $t_a$ :	40°C
Max. housing temperature $t_B$ :	80°C
<b>Minimum distance:</b>	
Minimum distance from flammable surfaces:	0,5 m
Minimum distance to lighted object:	1 m

Design and product specifications are subject to change without prior notice.



Website: [www.Showtec.info](http://www.Showtec.info)

Email: [service@highlite.nl](mailto:service@highlite.nl)

## Dimensions

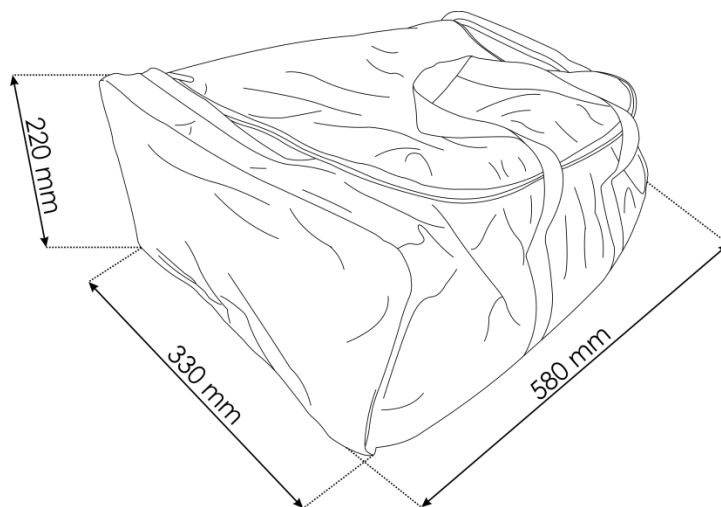
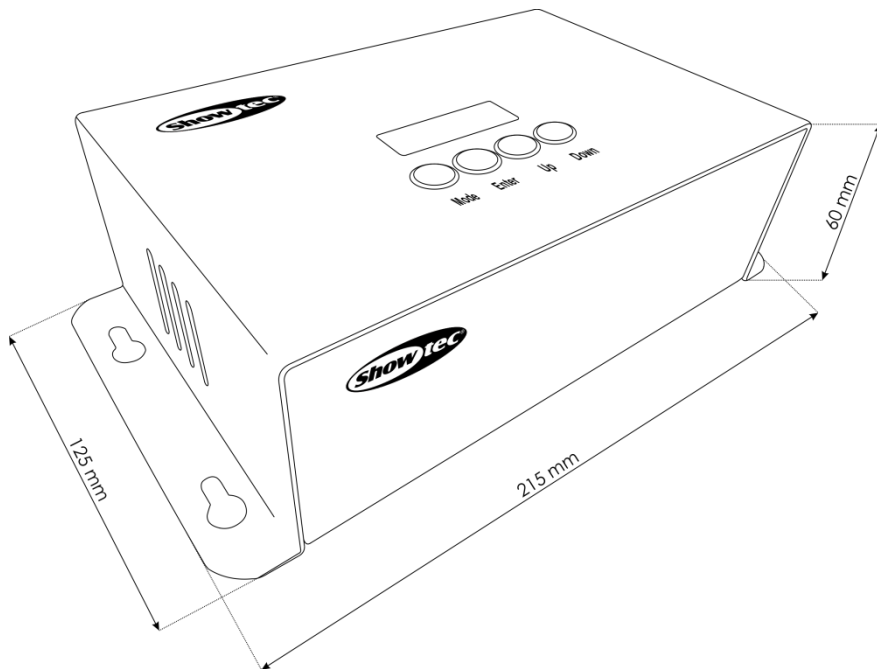
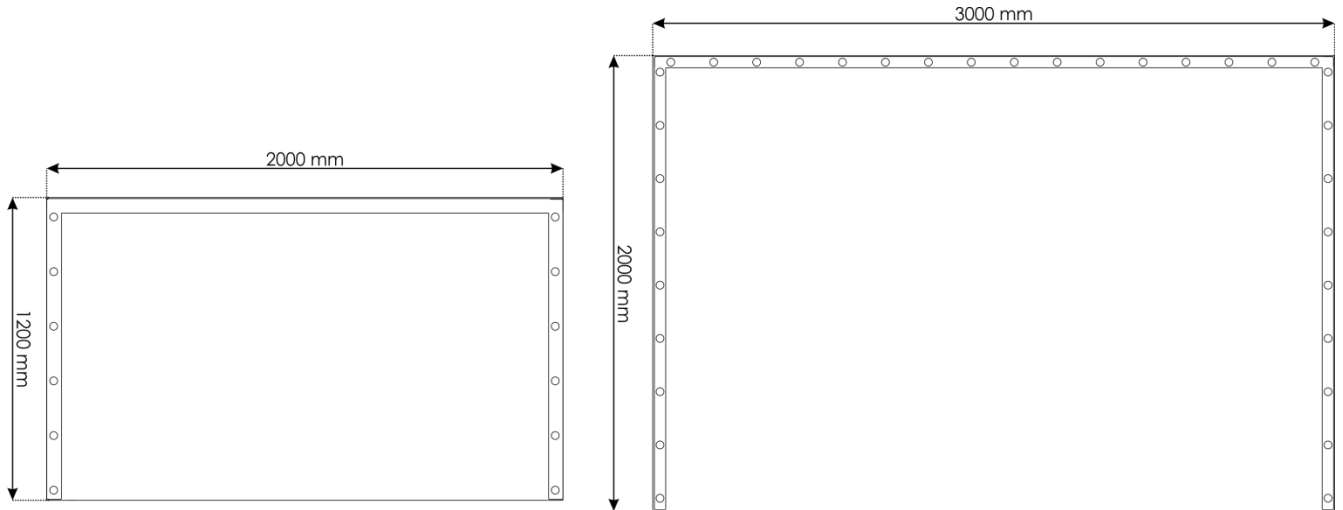







©2015 Showtec