

VT1 Special 2-points

A direct replacement for 2-point tremolo systems.

The pack includes, tremolo block, tremolo arm, high to ultra-low tension springs, fulcrum plate with fixing screws, 2 x Allen keys (1.5mm / 1/16" and 2.5mm / 3/32").

Two year warranty.

The pieces can be purchased individually.

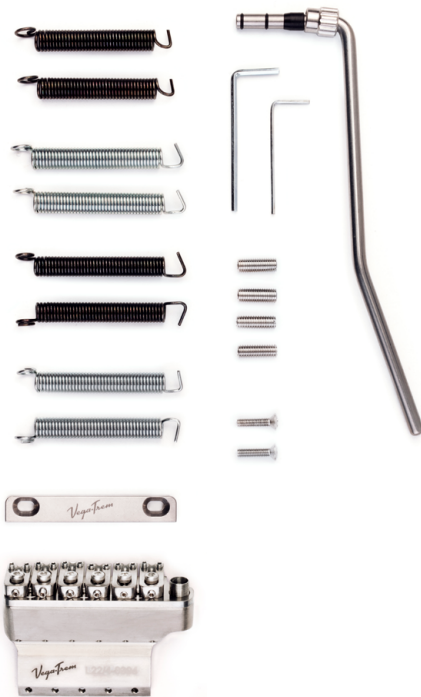

mm

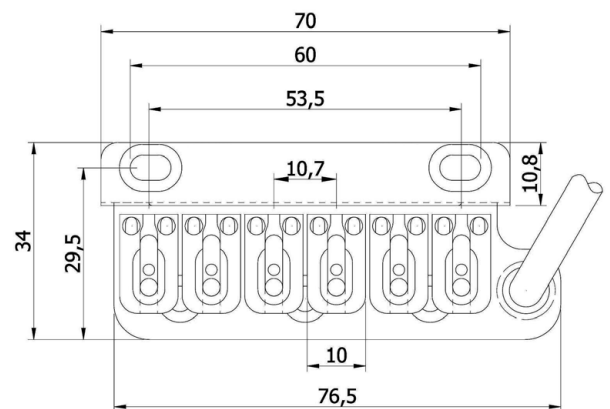

PRODUCT RESOURCES



ASSEMBLY INSTRUCTIONS



THE CORRECT USE OF SPRINGS









FAQ's

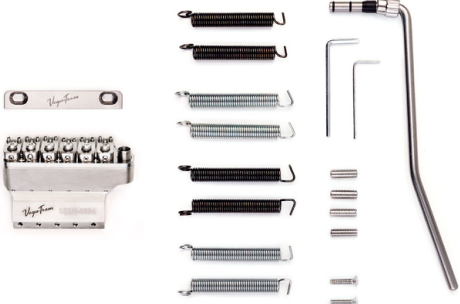

Vega-Trem

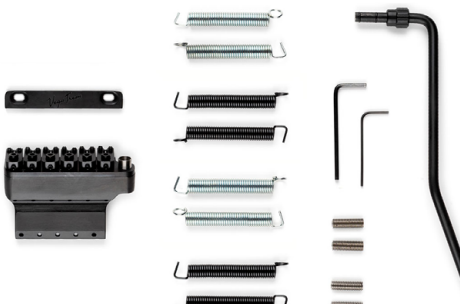
2-POINTS MODELS

	<p>VT1 Special 2-points</p> <p>Finished in high quality stainless steel. Brass block.</p>	
	<p>VT1 Special 2-points Gold</p> <p>Finished in high quality stainless steel. Brass block.</p>	
	<p>VT1 Special 2-points Black</p> <p>Finished in high quality stainless steel. Brass block.</p>	
	<p>VT1 Special 2-points Satin</p> <p>Finished in high quality stainless steel. Brass block.</p>	